

PYRAMID™

4000 Pro

5000⁺ / 5000⁺HD

Auto Totaling Time Clock

User Guide

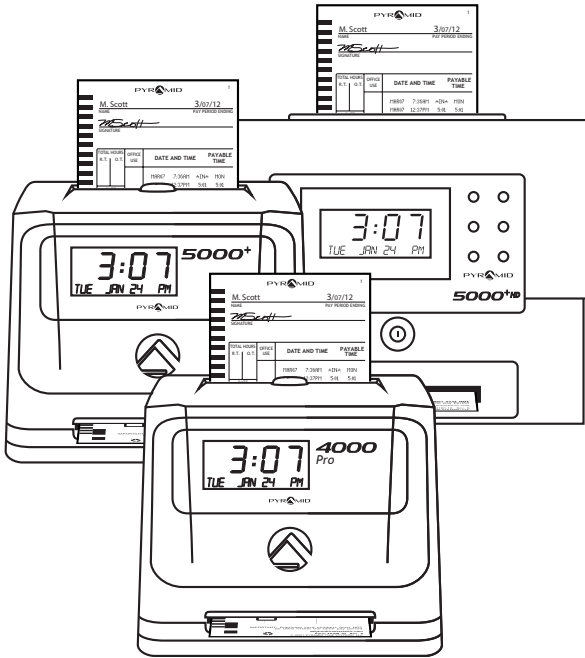

AUTO TOTALING TIME CLOCK INSTRUCTIONS

Model 4000Pro/5000+/5000+HD

SIMPLE ⚡ SMART®

Copyright Information

© 2021 Pyramid Time Systems, LLC. All rights reserved.

Reproduction, adaptation or translation without prior written permission is prohibited, except as allowed under the copyright laws.

The information contained herein is subject to change without notice.

The only warranties for Pyramid Time Systems products are set forth in the express warranty statements accompanying such products. Nothing herein should be construed as constituting an additional warranty. Pyramid Time Systems shall not be liable for technical or editorial errors or omissions contained herein.

TABLE OF CONTENTS

TABLE OF CONTENTS 1

PRODUCT OVERVIEW 2

FEATURES 2

CONTENTS 3

INSTALLATION & PROGRAMMING 4

FEATURES SET UP 5

SET UP PAY 6-8

TIME CARDS 9

PRINT FORMAT 9

BUZZERS, BELLS & WALL CLOCKS 10-11

USING TIME CLOCK. 12

REPLACING RIBBON CARTRIDGE 13

TROUBLESHOOTING 14

MASTER RESET. 14

FAQs 15

ACCESSORIES 15

SPECIFICATIONS 16

WARRANTY & CUSTOMER SUPPORT 17

CONTACT US 18

PRODUCT OVERVIEW

Thank you for choosing a **4000Pro/5000+ Series Auto Totaling Time Clock!**
 The 4000Pro/5000+ Series Time Clock features automatic employee time totaling for accurate, error-free payroll tracking. Tally weekly, every 2 weeks, bi-monthly or monthly pay periods for up to 100 employees (4000Pro - 50 employee limit).
 Simple set-up, simple operation & simple ribbon changes make this time clock a favorite with small business!

Please read through this User Guide for simple set-up & operation.

AUTO TOTALING TIME CLOCK : FEATURES

Employee Capacity	5000 Series - 100
	4000Pro - 50
Card Alignment	Top
Auto Totaling	Yes
Pay Period	Weekly, every 2 weeks, Bi-monthly, monthly
Punch Rounding	0, 5, 10 or 15 minute intervals
Ribbon Ink	Black
Audio Signal	Buzzer
Bell Interface	Yes
Wall Clock Interface	Yes
Language Printing	English, Spanish, French & German
Display	Time, Date & Day of Week, backlit LCD screen
Printing Format	Year, Date & Time (select AM/PM, military or true military)
Printing	Dot matrix
Automatic Time Reset	Short months, Leap Year & Daylight Savings Time
Battery Back-Up	Safeguards data & settings for up to 60 days without power
Tamper-Proof	Security lock protects against costly time theft
Warranty	1-Year manufacturer's limited warranty

CONTENTS

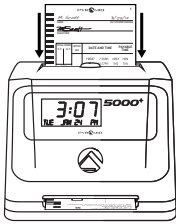

4000Pro/5000+ Series Auto
Totaling Time Clock

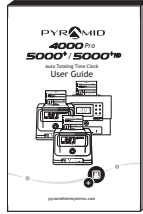

4000Pro/5000+/5000+HD
User Guide

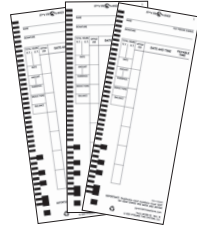

44100-10
Time Card (25)

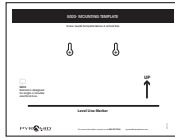

Mounting
Template



Security
Keys (2)

WHAT YOU WILL NEED

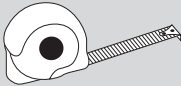

Tape Measure



Pencil



Phillips Head
Screw Driver



Power Drill
(Optional)

KNOW YOUR SERIAL #

IMPORTANT:

Please write down serial #
located on back of time
clock before mounting.

SAMPLE

000000500012335040

Write your
serial # here:

DESKTOP SET UP

- 1 Remove time clock from carton & place on a flat, level surface.
- 2 Plug unit into AC wall outlet.

WALL MOUNTING

- 1 Select a location convenient to employees clocking IN & OUT. Be sure power outlet is within 5 feet of mounting location.
- 2 Use masking tape to hold mounting template on wall, making certain template is positioned so bottom of time clock is approximately 45 inches from floor.
- 3 Drill holes using template as a guide.
- 4 Remove template from wall & install #10 screws, leaving approximately 3/16 inch of screws exposed. For sheetrock walls, use plastic anchors.
- 5 Hang time clock on wall, aligning keyholes on the rear with screw heads. Press downward on time clock until it lowers onto screws. If mounting 5000+HD Time Clock, unlock & remove top/front cover, & tighten wall screws to fasten.
- 6 Plug unit into AC wall outlet.

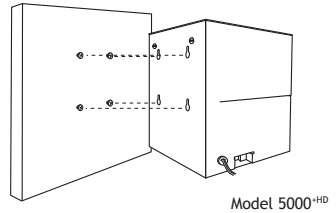
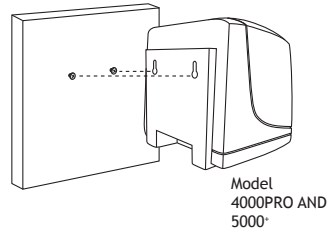

PROGRAMMING

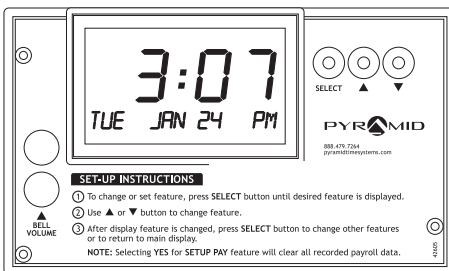

- 1 Use key to unlock & remove top/front cover. Locate programming buttons labeled SELECT, ▲(UP) & ▼(DOWN).
- 2 Press SELECT until desired feature is displayed (see chart on page 5).
- 3 Press ▲(UP) or ▼(DOWN) to scroll through feature options.
- 4 Press SELECT to save option setting & move to next feature.

AUTO TOTALING TIME CLOCK INSTRUCTIONS

Model 4000Pro/5000+/5000+HD

SIMPLE 8 SMART®

AUTO TOTALING TIME CLOCK : FEATURES SET UP

FEATURE (SELECT)	DISPLAY	DEFAULT SETTING	OPTIONS (SCROLL ▲▼)
Set Language	LANG =	ENGLISH	ENGLISH, French (FRANCAIS) Spanish (ESPAÑOL) German (DEUTSCH)
Set Date Format	DATE FMT =	USA	USA: MM/DD/YR, EURO: DD/MM/YR
Set Year	SET YEARR =	2012	DISPLAYED YEAR +/- 1 Year
Set Month	SET MONTH =	JAN	DISPLAYED MONTH +/- 1 Month
Set Date	SET DAY =	1	DISPLAYED DATE +/- 1 Day
Set Daylight Savings Time (DST) Rule at 2am	DAYL'T SRV =	USA	USA: USA DST: Begins 2nd SUN of MAR, Ends 1st SUN of NOV EURO: European DST: Begins Last SUN of MAR, Ends Last Sun of OCT OTHER: Set a custom DST Rule See Set DST Rule OFF: No adjustment for DST.
Set Format	DSPLY FMT =	AM/PM	AM/PM: 12 Hour, MIL: Military, 24 Hour
Set Printed Time Format	PRINT FMT =	AM/PM	AM/PM: 12 Hour (e.g. 3:30PM) MIL: Military, 24 Hour (e.g. 15:30) ATAAP: Military, 24 Hour, Minutes expressed in hundredths of one hour (e.g. 15.50)
Set Hour	SET HOUR =	12AM	DISPLAYED HOUR +/- 1 Hour
Set Minutes	SET MINUTES =	00	DISPLAYED MINUTE +/- 1 Minute
Schedule an Event (e.g. ring bells)	SET EVENT #	NO	NO: No event(s) scheduled. YES: Schedule event(s) SET EVENT #1-50 (see pages 10&11)
Setup Pay Period Options	SETUP PAY ?	NO	NO: No pay period options configured. YES: Setup pay period options (see pages 6-8)

SET UP PAY

Pyramid's Auto Totaling Time Clocks record & summarize payroll information for up to 100 employees on a weekly, every 2 weeks, bi-monthly, or monthly basis. Use the SETUP PAY? Feature to select desired pay period.

MENU : SETUP PAY? ▼▲ Set How Time Clock Calculates Totals

FEATURE (SELECT)	DISPLAY	DEFAULT SETTING	OPTIONS (SCROLL ▲▼)
Set Custom Totaling Settings	SETUP PAY ?	NO	YES/NO: Select YES to set up pay period options¹
Are you sure you want to clear stored data/totals?	ARE YOU SURE?	NO	YES/NO: Select YES to continue setting up pay period options¹
Set printed format for payable time	TOTAL FMT =	HR:MIN	HR:MIN: Std. hours & minutes format (e.g. 8 hours, 30 minutes printed as 8:30) HR.HUN: Std. hours with minutes as hundredths of one hour (e.g. 8 hours, 30 minutes printed as 8.50)

(continued on next page)



IMPORTANT:

SELECTING YES IN SETUP PAY? MENU AFTER INITIAL SETUP WILL ERASE ALL STORED DATA & NEW TIME CARDS MUST BE ISSUED. However, you may change all other features (language, date format, year, month, date, DST, etc.) without effecting time totals, even while a user is clocked IN.

SET UP PAY (cont.)

MENU : SETUP PAY? ▼▲ Set How Time Clock Calculates Totals

FEATURE (SELECT)	DISPLAY	DEFAULT SETTING	OPTIONS (SCROLL ▲▼)
Set pay period duration	RESET =	WEEKLY	<p>WEEKLY: Administer weekly payroll</p> <p>MONTHLY: Administer monthly payroll</p> <p>EVERY 2 WEEKS: Administer payroll every other week on same day of week</p> <p>BI-MONTHLY: Administer payroll on two selected days during month</p>
Select First Day of Pay Period or Reset Day ¹ (WEEKLY)	RESET DAY = (FOR WEEKLY)	SUN	SUN, MON, TUE, WED, THU, FRI, SAT: the day pay period begins
Select First Day of Pay Period or Reset Day ¹ (MONTHLY)	RESET DAY = (FOR MONTHLY)	1st	<p>1st: Resets first day of month</p> <p>LAST: Resets last day of month</p> <p>LAST-1: Resets one day before last day of month</p> <p>LAST-2: Resets two days before last day of month</p> <p>LAST-3: Resets three days before last day of month</p> <p>LAST-4: Resets four days before last day of month</p> <p>LAST-5: Resets five days before last day of month</p>
Select first date of pay period or reset date (EVERY 2 WEEKS)	RESET =	DAY MONTH DATE	<p>Select 1st-14th of given month</p> <p>NOTE: Clock will reset every two weeks from chosen date</p>
Select first day of period or reset days (BI-MONTHLY)	RST =	15th & LAST	<p>15th & LAST: Resets 15th and last day of month</p> <p>14th & LAST-1: Resets 14th and one day before last day of month</p> <p>13th & LAST-2: Resets 13th and two days before last day of month</p> <p>12th & LAST-3: Resets 12th and three days before last day of month</p> <p>11th & LAST-4: Resets 11th and four days before last day of month</p> <p>10th & LAST-5: Resets 10th and five days before last day of month</p> <p>16th & 1st: Resets 16th and first days of month</p>



(continued on next page)

¹Reset Day & Time is desired day & time for new pay period. Employee begins new time card on this day.

SET UP PAY (cont.)

MENU : SETUP PAY? ▼▲ Set How Time Clock Calculates Totals

FEATURE (SELECT)	DISPLAY	DEFAULT	OPTIONS (SCROLL ▲▼)
Set reset time for reset day or days	RESET HOUR =	10PM	Recommend setting one hour prior to shift start time of new pay period (e.g. 6:00AM reset time for a 7:00AM start time)
Set number of hours allowed between punches ¹	MAX HRS/ PUNCH =	13	10-99 Hours

FEATURE (SELECT)	OPTIONS (SCROLL ▲▼)
Configure rounded time/ flex time/ grace period	<p>NONE (Default Setting): Rounding off. Calculates totals using exact in/out punch times</p> <p>5 MIN: Five minute intervals. Rounds forward up to two minutes before & backward up to three minutes after:</p> <p>so, Punch In - 8:02AM (rounds to 8:00AM), Punch Out - 11:58AM (rounds to 12:00PM). Running Total = 4:00</p> <p>or, Punch In - 8:04AM (rounds to 8:05AM), Punch Out - 11:56AM (rounds to 11:55AM). Running Total = 3:50</p> <p>10 MIN: Ten minute intervals. Rounds forward five minutes before & backwards up to five minutes after ten minute interval:</p> <p>so, Punch In - 8:04AM (rounds to 8:00AM), Punch Out - 11:56AM (rounds to 12:00PM). Running Total = 4:00</p> <p>or, Punch In - 8:06AM (rounds to 8:10 AM), Punch Out - 11:54AM (rounds to 11:50AM). Running Total = 3:40</p> <p>15 MIN: or 7/8 Rule. Fifteen minute intervals. Rounds forward up to seven minutes before & backward up to eight minutes after:</p> <p>so, Punch In - 7:52AM (rounds to 7:45AM), Punch Out - 12:09PM (rounds to 12:15PM). Running Total = 4:30</p> <p>or, Punch In - 7:53AM (rounds to 8:00AM), Punch Out - 12:04PM (rounds to 12:00PM). Running Total = 4:00</p>



¹Before it is assumed there is a missed punch.

TIME CARDS

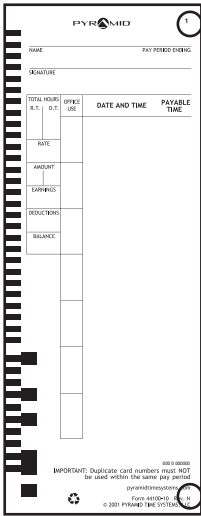

Time Card #44100-10

- ① Use one number per person per period. Do not duplicate numbers during a pay period.
- ② Use clean, straight cards to avoid read/ID errors.
- ③ Locate the revision # at bottom of card. Use Pyramid Rev. I or higher cards. Contact technical support if you have lower revision cards.
- ④ Use only time card #44100-10 which includes official Pyramid Time Systems Trademark. Using time cards other than Pyramid item #44100-10 voids the warranty.

TIME CARD PRINT FORMAT

The same time card (#44100-10) is used for weekly, monthly, every 2 weeks & semi-monthly pay periods. However, the print format will differ as follows:

WEEKLY:

Up to a maximum 28 punches per period, typically (but not necessarily), 4 punches a day over 7 days.

PUNCH IN **MAY 9 8:00AM *IN* WED**
 Prints Month, Date, Punch In Time, "IN", Day of Week

PUNCH OUT **MAY 9 12:00PM 4:00 4:00**
 Prints Month, Date, Punch Out Time, Elapsed Time since last "IN" Punch (HRS:MIN), Running Total (HRS:MIN)

MONTHLY, EVERY 2 WEEKS, SEMI-MONTHLY:

Up to a maximum 64 punches per period, typically (but not necessarily), one in/one out punch per line over 32 lines.

PUNCH IN **9 8:00A**
 Prints Date, Punch In Time

PUNCH OUT **9 8:00A 12:00P 4:00 4:00**
 Prints Punch Out Time, Elapsed Time since last IN Punch (HRS:MIN), & Running Total (HRS:MIN) to the right of existing Punch In Time

SET EVENT USING BUZZER/BELLS

The time clock has an internal buzzer & bell ringer interface option to alert workers (or students) of start times, breaks, lunch and dismissal times. The internal buzzer will also sound when the time clock sends a BCD signal to ring a bell.

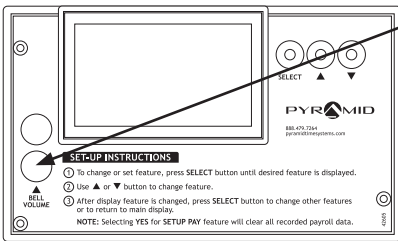

- 1 Locate volume dial inside front cover to left of display.
- 2 Turn dial clockwise to increase volume & counterclockwise to decrease. NOTE: Buzzer is intended for use in quiet settings.
- 3 Sound the buzzer by scheduling an event (See Event Menu on page 11).

CONNECTING EXTERNAL BELLS

Add up to 15 bells and/or horns & schedule up to 50 events using Pyramid Time System's TimeTrax™ Model 5300 Bell Ringer (sold separately).

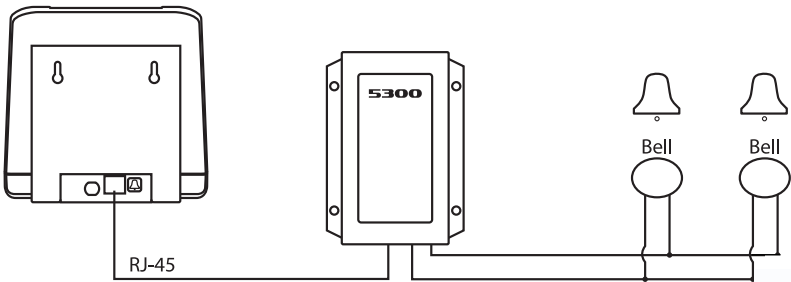

- 1 Locate RJ-45 jack at back (4000Pro/5000+) or side (5000+HD) of time clock & connect cable.
- 2 Connect other end of cable to TimeTrax™ 5300 Bell Ringer.
- 3 Wire bells and/or horns in parallel to labeled bell out terminals (+-) on the 5300. See TimeTrax™ 5300 Instructions for detailed installation instructions.
- 4 Set bell or horn by scheduling an event (see page 11).

SET EVENT

MENU : SET EVENT ▼▲

SCHEDULE AN EVENT (e.g. Ring Internal Buzzer/External Bells)

FEATURE (SELECT)	DISPLAY	DEFAULT SETTING	OPTIONS (SCROLL ▲▼)
Set Event Schedule	SET EVENT *	NO	Scroll ▲(UP) or ▼(DOWN) to schedule event
Assign the Event a Number (1-50)	SET EVENT *		SET EVENT (e.g. 1, 2, 3 ... 50)
Set the Event's Duration	EVENT #	OFF	OFF, .5 SEC, 1-15 SEC (determines length of time buzzer/bell sounds)
Set the Event's Hour	EVENT # HR =	12 HR: 12AM 24 HR: 00	EVENT HOUR +/- One Hour 12 HR: 12AM-11PM 24 HR: 00-23
Set the Event's Minute	EVENT # MIN =	00	EVENT MINUTE +/- One Minute (e.g. 00, 17, 59)
Set the Event's Day	EVENT # DAY =	ALL	One day event: SUN, MON, TUE, WED, THU, FRI, SAT All week event, SUN-SAT: ALL Monday thru Friday Event: M-F

CONNECTING BELL AND/OR EXTERNAL CLOCKS

The time clock is able to send time signal to TimeTrax™ Sync 5200N Analog Clock or DIG4B Digital Clock. TimeTrax™ Sync wall clocks can be used alone, or in conjunction with TimeTrax™ Sync 5300 Bell Ringer.

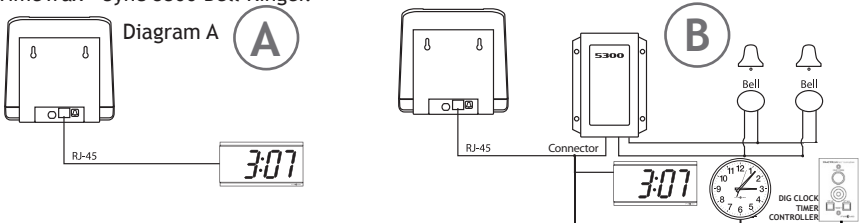

- 1) Locate RJ-45 jack at back (4000Pro/5000+) or side (5000+HD) of time clock & connect cable (sold separately).
- 2) Connect other end of cable to Pyramid Digital Clocks (DIG4B, DIG6B) (diagram A). If using TTsync 5300 Bell Ringer and Clocks, connect RJ-45 cable to T-Connector (part #41270 sold separately) and connect to Bell Ringer and clocks (diagram B). Follow Bell Ringer steps 3-5 on previous page.
- 3) Plug digital wall clock into AC wall outlet. The 5300 can power up to 8 5200N or 5217N Analog Clocks

USING TIME CLOCK

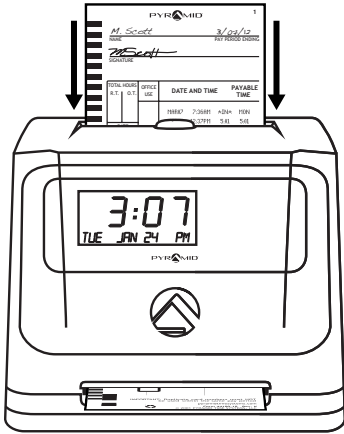

- ① To Punch IN or OUT, gently feed time card (#44100-10) into time card slot located at the top of the time clock.
- ② Quickly release the card, as it will automatically be pulled through the clock.
- ③ Do not force or jam the time card.

REPLACING RIBBON CARTRIDGE

For optimum performance, the ribbon cartridge should be replaced every 6 months.

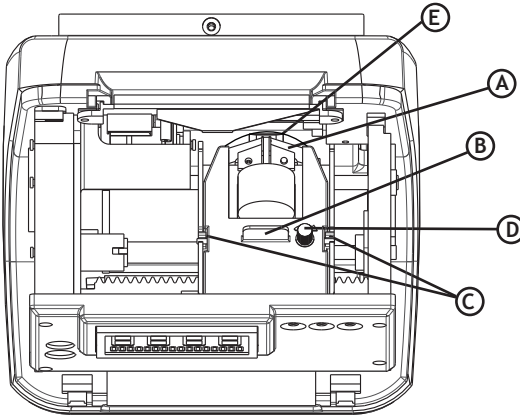

- A - Print Head C - Retaining Pins
B - Tab D - Manual Advance Knob
E - Clear Mylar Strip

- ① To remove old ribbon, lift ribbon cartridge straight up using the tab **B** located on top of cartridge.
- ② Remove new ribbon cartridge from packaging & turn the manual ribbon advance knob **D** clockwise to straighten ribbon.
- ③ Holding tab, install ribbon cartridge into print carriage, making certain retaining pins **C** are aligned to rear of carriage clips & ribbon is between print head **A** and clear mylar strip **E** (see diagram).
- ④ Gently push down cartridge until it snaps into carriage while turning the manual ribbon advance knob clockwise.
- ⑤ Turn manual ribbon advance knob clockwise a few rotations to ensure ribbon is positioned correctly in front of print head.
- ⑥ Replace the cover & lock unit.
- ⑦ Feed a time card through unit to test print quality.



If time clock prints incomplete characters, the ribbon is not fully installed over print head. If time clock prints lines that become increasingly light, the cartridge is not fully snapped into the holder. Reinstall ribbon cartridge, following steps 1-7 until a complete & consistent time card prints.

For assistance, please contact customer support at 888.479.7264 ext 1.

TROUBLESHOOTING

TRY AGAIN MESSAGE

In the event the time clock displays “TRY AGAIN”, re-feed the time card. If “TRY AGAIN” persists, please check list for possible causes:

4000Pro/5000+/5000+HD : TRY AGAIN MESSAGE

POSSIBLE CAUSES	ACTION
Time card inserted too hard into time clock	Re-Feed Card
Time card held too long	Re-Feed Card
Time card inserted into time clock on an angle	Re-Feed Card
Time card is wet or swollen	Use new Time Card
Bar code read error	Use only Pyramid Time Cards Ensure time card bar code isn't covered or damaged

IMPAIRED PRINTING

In the event the time clock printing is impaired, please check list for possible causes:

4000Pro/5000+/5000+HD : IMPAIRED PRINTING

SYMPTOM	PROBABLE CAUSE	ACTION
Time card feeds with no printing	Ribbon not installed properly	Check that ribbon cartridge is properly installed
	Time card bar code covered or damaged	Use new time card
Overlapping punches or large space between punches	SETUP PAY options changed without issuing new time cards or you said YES to SETUP PAY & ARE YOU SURE? without issuing new card	Adjust totaled hours manually at end of pay period
	Duplicate card numbers used in same pay period	Perform MASTER RESET
	Pay period may be set up incorrectly	Check pay period setup
	Total hours between In & Out Punch exceeds MAXHRS/Punch setting	

EXCEEDED EMPLOYEE LIMIT

In the event the time clock displays “50 EMP LIMIT”, you have reached the maximum number of employees for this model (4000Pro). If you need to add more employees, please upgrade to a 5000 Series Time Clock by either visiting pyramidthimesystems.com or calling customer service at 888.479.7264.

MASTER RESET

Erases time clock’s memory & restores default factory settings:

- ① Unplug time clock, Press & hold ▲(UP) button while plugging unit back in.
- ② Release ▲(UP) button when PTR4000 or PTR5000 VER displays.
- ③ TIME NOT SET flashes on screen. Re-program time clock. Distribute new time cards.

FAQS

- Q:** When do I need new Time Cards?
A: First day of each new pay period, after making any changes in the SETUP PAY feature, or after Master Reset.
- Q:** Do I have to use consecutive numbered time cards during a pay period?
A: No. Issuing cards in sequential order avoids duplicating numbers during a pay period.
- Q:** Does the time clock calculate overtime?
A: The time clock provides a running total of all hours worked. Overtime policies vary from company to company and must be calculated manually.
- Q:** Does the time clock have an automatic lunch deduction feature?
A: The time clock provides a running total of hours between punches & therefore any payroll deductions must be calculated manually at end of pay period.
- Q:** What does ATAAP mean?
A: ATAAP is the acronym used by the U.S. government that describes how time is accounted for using hundredths of hour (i.e. one and a quarter hours equals 1.25 hours).

ACCESSORIES

4000Pro/5000+/5000+HD : ACCESSORIES

ITEM #	DESCRIPTION
5000R	Replacement Ink Ribbon Cartridge
44100-10	Time Cards (100pk)
44100-10F	English/French Time Cards (100pk)
44100-10M	Time Cards (1000pk)
400-3	25 Capacity Adjustable Time Card Rack
300-1	Heavy Duty Metal Time Card Rack
400-X	25 Capacity Expanding Time Card Rack
5300	TimeTrax™ Sync Bell Ringer
41361	TimeTrax™ Sync 6in 24 Volt Bell
41392	TimeTrax™ Sync 8in 24 Volt Bell
5200N	TimeTrax™ Sync Analog Clock 13"
5217N	TimeTrax™ Sync Analog Clock 17"
DIG4B	TimeTrax™ Sync Digital Clock 4 Digit
DIG6B	TimeTrax™ Sync Digital Clock 6 Digit
41269	RJ-45 Cable 50 Ft
41270	T-Connector
CTPLATEKIT	Timer Controller (allows count up/down for Dig 4B & 6B)

**To order accessories visit pyramiddtimesystems.com
 or call 888.479.7264**

SPECIFICATIONS

4000Pro/5000+/5000+HD : SPECIFICATIONS

OPERATING CONDITIONS	
Temperature	0° C - 50° C, 32° F - 122° F
Humidity	10-95% RH, non condensing
POWER FAILURE	
Battery Back-Up	60 Days Data & Time
Battery Life	10 Years
CALENDAR	Automatic Leap Year & Daylight Savings Time
CLOCK ACCURACY	Less than 30 seconds/year
MEMORY CAPACITY	5000+ Series - 100 Employees
	4000Pro - 50 Employees
BCD SIGNAL/TIME UPDATE	Up to 6 clocks (5200N, 5217N, DIG4B & DIG6B)
POWER	100-240 V AC, 50/60 Hz
CERTIFICATIONS	UL & CUL
WEIGHT	
4000Pro /5000	3.5lbs (1.6kg)
5000HD	7.4lbs (3.35kg)
DIMENSIONS	
4000Pro /5000	7inW x 7.25inH x 6.5inD (17.8 cm x 18.4 cm x 16.5 cm)
5000HD	8.75inW x 7.25inH x 7.5inD (22.2 cm x 18.4 cm x 17.4 cm)
MOUNTING	Desktop or Wall

LIMITED HARDWARE WARRANTY

- Pyramid Time System warrants its equipment to original user against defective material or workmanship for a period of 1-year from date of purchase. Proof of purchase & purchase date are required for warranty service on this product. Please remember to register your product at pyramidthimesystems.com/ProductRegistration/.
- Pyramid Time Systems' responsibility under this warranty is limited to replacement of defective part(s). Replacement is the sole discretion of Pyramid Time Systems.
- For Return Shipments to Pyramid Time Systems, product must be shipped in its original carton or equivalent. The return freight method and cost for warranted product is the sole responsibility of the customer. Pyramid Time Systems will not assume any responsibility for loss or damage incurred in shipping.
- Pyramid Time Systems reserves the right to determine whether parts failed because of defective material, workmanship or other causes.
- Failure caused by accident, alteration, misuse or improper packaging of returned unit is not covered by this warranty.
- Any repair done by the customer without the consent from Pyramid Time Systems will automatically void the warranty.
- Users in countries other than Canada and USA should contact the Dealer from whom the unit was purchased.
- The rights under this warranty are limited to the original user and may not be transferred to subsequent users.

MONEY BACK GUARANTEE

Pyramid Time Systems offers a 30-day money back guarantee. If an RMA is issued for an unwanted product before 30 days, Pyramid Time Systems will refund the entire purchase price less shipping if purchased from Pyramid Time Systems. Pyramid Time Systems will assess a 15% restocking fee on any returns received between 31 and 60 days from the date of purchase. No returns will be accepted after 60 days. Pyramid Time Systems will not issue a call tag for pickup of products. Customers are responsible for shipping the product back including the cost of shipping. Pyramid Time Systems will assume the cost of ground shipping for the replacement product to the customer. Pyramid Time Systems will also assess a 15% fee if any item(s) are missing in an open box return. Shipping back to Pyramid Time Systems from a Pyramid Time Systems Partner is the responsibility of the Pyramid Time Systems Partner. No call tags will be issued. Items returned to Pyramid Time Systems without an RMA will not be credited. No returns will be accepted for opened TimeTrax™ PC products.

SIMPLE ∅ SMART®



CONTACT US:

For more information, visit pyramidtimesystems.com or call our technical support team at **888.479.7264** during regular business hours: **8:30am-5:00pm EST, Monday-Friday.**

Copyright © 2021 Pyramid Time Systems, LLC. All rights reserved.

